

LANDMARK/LMK, REEDED & BAUHAUS  
cabinet hardware collections



SAMUEL HEATH

*Handmade in England*

# SAMUEL HEATH

*Handmade in England*

Our cabinet hardware is turned from solid brass bars in our factory in Birmingham, England, then polished and plated by hand in finishes ranging from City bronze to Anthracite. They match the rest of our brassware and door hardware perfectly.

*Adorning the world's finest homes*

LANDMARK / LMK, REEDED & BAUHAUS  
cabinet hardware collections



P8256K Cabinet and appliance pull handles



**P8256K-A**  
Length:  
143mm, 5<sup>5</sup>/<sub>8</sub>"  
Centres:  
128mm, 5<sup>1</sup>/<sub>16</sub>"



**P8256K-E**  
Appliance pull  
Length:  
399mm, 15<sup>11</sup>/<sub>16</sub>"  
Centres:  
384mm, 15<sup>1</sup>/<sub>8</sub>"



**P8256K-B**  
Length:  
175mm, 6<sup>7</sup>/<sub>8</sub>"  
Centres:  
160mm, 6<sup>5</sup>/<sub>16</sub>"



**P8256K-F**  
Appliance pull  
Length:  
623mm, 24<sup>1</sup>/<sub>2</sub>"  
Centres:  
608mm, 23<sup>15</sup>/<sub>16</sub>"



**P8256K-C**  
Length:  
239mm, 9<sup>7</sup>/<sub>16</sub>"  
Centres:  
224mm, 8<sup>9</sup>/<sub>16</sub>"

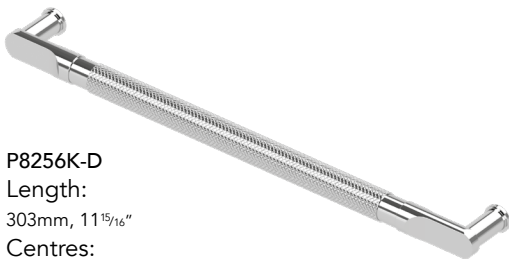

**P8256K-D**  
Length:  
303mm, 11<sup>15</sup>/<sub>16</sub>"  
Centres:  
288mm, 11<sup>5</sup>/<sub>16</sub>"



Visit our website to view each product in each finish available.

PK8256P Cabinet and appliance pull handles

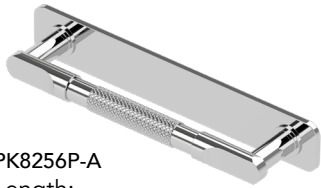

PK8256P-A  
Length:  
160mm, 6<sup>5</sup>/<sub>16</sub>"  
Centres:  
128mm, 5<sup>1</sup>/<sub>16</sub>"

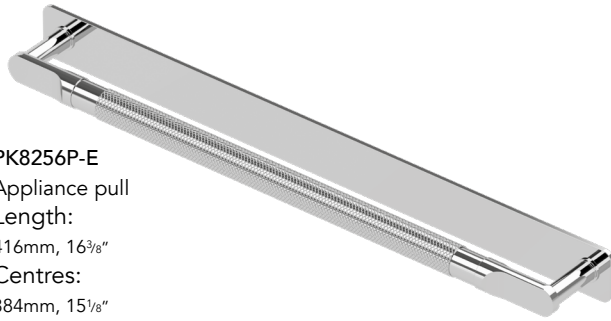

PK8256P-E  
Appliance pull  
Length:  
416mm, 16<sup>3</sup>/<sub>8</sub>"  
Centres:  
384mm, 15<sup>1</sup>/<sub>8</sub>"

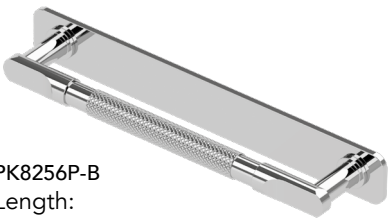

PK8256P-B  
Length:  
192mm, 7<sup>7</sup>/<sub>16</sub>"  
Centres:  
160mm, 6<sup>5</sup>/<sub>16</sub>"

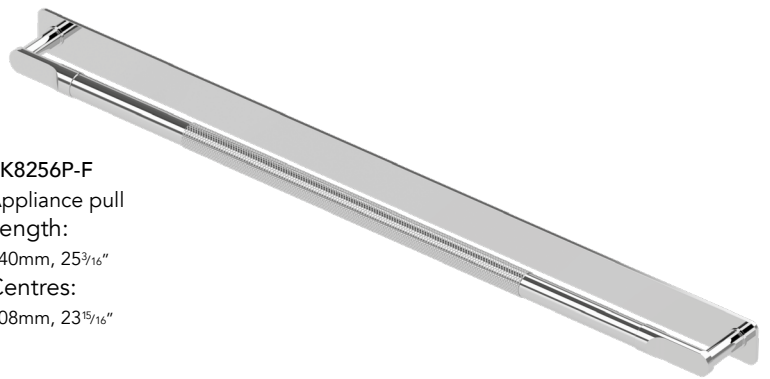

PK8256P-F  
Appliance pull  
Length:  
640mm, 25<sup>3</sup>/<sub>16</sub>"  
Centres:  
608mm, 23<sup>15</sup>/<sub>16</sub>"

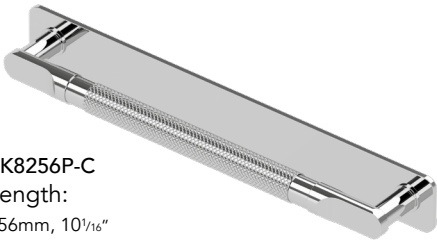

PK8256P-C  
Length:  
256mm, 10<sup>1</sup>/<sub>16</sub>"  
Centres:  
224mm, 8<sup>13</sup>/<sub>16</sub>"

*The machined knurling on our Industrial handles is gently polished back by hand to give a wonderfully luxurious feel to the grip.*

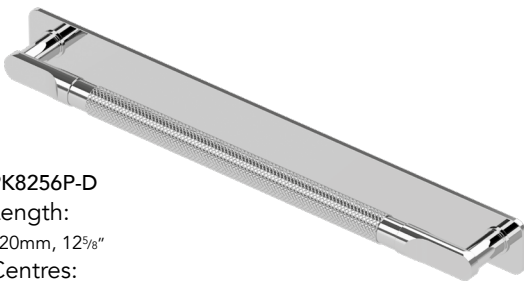

PK8256P-D  
Length:  
320mm, 12<sup>5</sup>/<sub>8</sub>"  
Centres:  
288mm, 11<sup>5</sup>/<sub>16</sub>"



Visit our website to view each product in each finish available.

P8250 Cabinet and appliance pull handles



**P8250-A**  
Length:  
175mm, 6<sup>7</sup>/<sub>8</sub>"  
Centres:  
100mm, 3<sup>15</sup>/<sub>16</sub>"



**P8250-E**  
Appliance pull  
Length:  
612mm, 24<sup>1</sup>/<sub>8</sub>"  
Centres:  
450mm, 17<sup>11</sup>/<sub>16</sub>"



**P8250-B**  
Length:  
225mm, 8<sup>7</sup>/<sub>8</sub>"  
Centres:  
150mm, 5<sup>7</sup>/<sub>8</sub>"



**P8250-F**  
Appliance pull  
Length:  
761.5mm, 30"  
Centres:  
599.5mm, 23<sup>5</sup>/<sub>8</sub>"



**P8250-C**  
Length:  
275mm, 10<sup>13</sup>/<sub>16</sub>"  
Centres:  
200mm, 7<sup>7</sup>/<sub>8</sub>"



**P8250-D**  
Length:  
461.5mm, 18<sup>3</sup>/<sub>16</sub>"  
Centres:  
300mm, 11<sup>13</sup>/<sub>16</sub>"



The knurled end sections can be ordered as split finishes. Visit our website to view each product in each finish available.

LANDMARK / LMK  
cabinet hardware collection



P799K-B

P800K-B

P799K-B

P800K-B

P8256K-C

P8256K-C

Landmark / LMK cabinet hardware in antique brass matt.

P799K and P800K Cabinet knobs



P799K-A  
Diameter: Ø 25mm, 1"  
Projection: 25mm, 1"



P800K-A  
Diameter: Ø 20mm, 13/16"  
Projection: 25mm, 1"



P799K-B  
Diameter: Ø 32mm, 1 1/4"  
Projection: 32mm, 1 1/4"



P800K-B  
Diameter: Ø 20mm, 13/16"  
Projection: 32mm, 1 1/4"

*The knurling on the cabinet knobs, like with the handles, is gently polished back so as not to feel too harsh to the touch, but still maintaining the crisp, engineered feel.*



CP Chrome plate  
PN Polished nickel  
BN Brushed nickel  
NL Non lacquered brass  
PB Polished brass  
MBC Matt black chrome  
ABU Antique brass unlacquered  
BG Brushed gold  
BGG Brushed gold gloss  
BGM Brushed gold matt  
ANT Anthracite  
ABM Antique brass matt  
ABG Antique brass gloss  
AMR Amber brass  
OBM Old brass matt  
CTB City bronze  
CNB Country bronze

Visit our website to view each product in each finish available.

LANDMARK / LMK  
cabinet hardware collection



Landmark / LMK cabinet hardware in  
antique brass matt.

SAMUEL HEATH

*Handmade in England*

REEDED  
cabinet hardware collection



P799L-B



P799L-B



P8258-C



P8258-B



P800L-B



P800L-B

Reeded cabinet hardware in  
Anthracite and Old brass matt.

# Reeded

## P8258 Cabinet and appliance pull handles



**P8258-A**  
Length:  
144mm, 5<sup>11</sup>/<sub>16</sub>"  
Centres:  
128mm, 5<sup>1</sup>/<sub>16</sub>"



**P8258-E**  
Appliance pull  
Length:  
416mm, 16<sup>3</sup>/<sub>8</sub>"  
Centres:  
384mm, 15<sup>1</sup>/<sub>8</sub>"

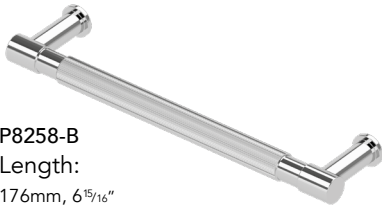

**P8258-B**  
Length:  
176mm, 6<sup>15</sup>/<sub>16</sub>"  
Centres:  
160mm, 6<sup>5</sup>/<sub>16</sub>"



**P8258-F**  
Appliance pull  
Length:  
668mm, 26<sup>5</sup>/<sub>16</sub>"  
Centres:  
608mm, 23<sup>15</sup>/<sub>16</sub>"

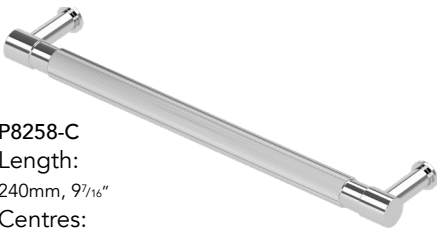

**P8258-C**  
Length:  
240mm, 9<sup>7</sup>/<sub>16</sub>"  
Centres:  
224mm, 8<sup>13</sup>/<sub>16</sub>"

*The reeded sections are precision cut on our CNC lathes but it is the final polishing by our master craftsmen that gently takes the sharpness away, leaving a luxurious brass texture.*



**P8258-D**  
Length:  
308mm, 12<sup>1</sup>/<sub>8</sub>"  
Centres:  
288mm, 11<sup>5</sup>/<sub>16</sub>"

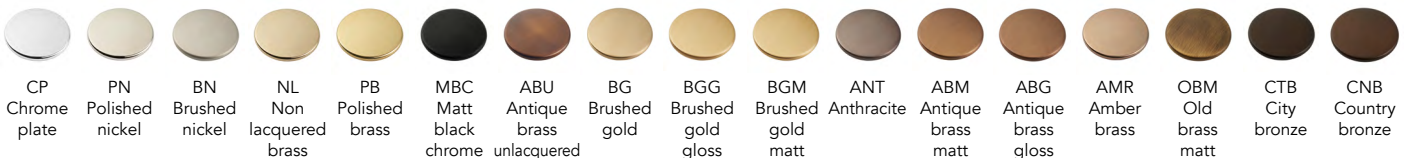

Visit our website to view each product in each finish available.

# Reeded

## PK8258P Cabinet and appliance pull handles



**PK8258P-A**  
Length:  
160mm, 6<sup>5</sup>/<sub>16</sub>"  
Centres:  
128mm, 5<sup>1</sup>/<sub>16</sub>"

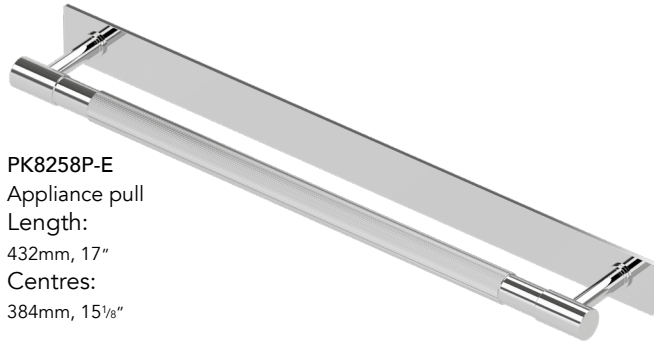

**PK8258P-E**  
Appliance pull  
Length:  
432mm, 17"  
Centres:  
384mm, 15<sup>1</sup>/<sub>8</sub>"

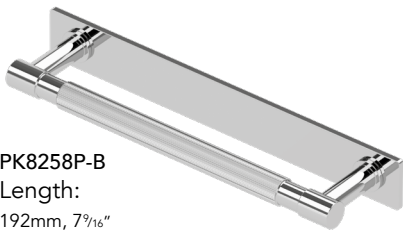

**PK8258P-B**  
Length:  
192mm, 7<sup>7</sup>/<sub>16</sub>"  
Centres:  
160mm, 6<sup>5</sup>/<sub>16</sub>"

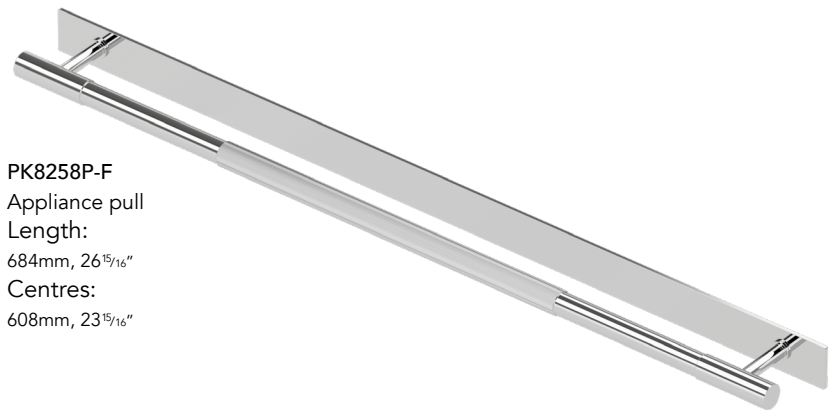

**PK8258P-F**  
Appliance pull  
Length:  
684mm, 26<sup>15</sup>/<sub>16</sub>"  
Centres:  
608mm, 23<sup>15</sup>/<sub>16</sub>"

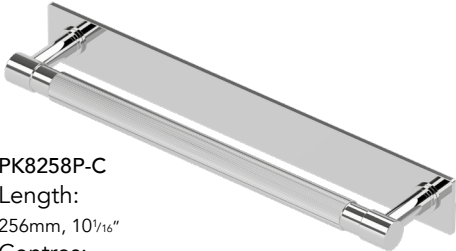

**PK8258P-C**  
Length:  
256mm, 10<sup>1</sup>/<sub>16</sub>"  
Centres:  
224mm, 8<sup>13</sup>/<sub>16</sub>"

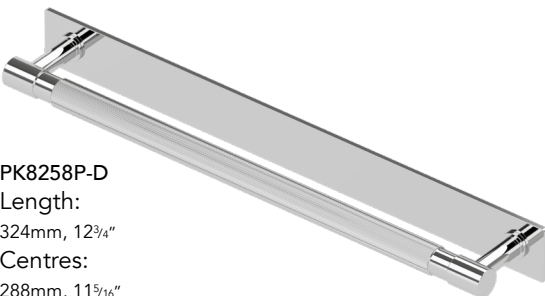

**PK8258P-D**  
Length:  
324mm, 12<sup>3</sup>/<sub>4</sub>"  
Centres:  
288mm, 11<sup>5</sup>/<sub>16</sub>"



Visit our website to view each product in each finish available.

REEDED  
cabinet hardware collection



P8258-C

P8258-B



P799L-B



P8258-C

P8258-B



P8258-C



P800L-B

P800L-B

Reeded cabinet hardware in  
Anthracite and Old brass matt.



P799L-B

P799L-B

# Reeded

## P8254 Cabinet and appliance pull handles



**P8254-A**  
Length:  
175mm, 6<sup>7</sup>/<sub>8</sub>"  
Centres:  
100mm, 3<sup>15</sup>/<sub>16</sub>"



**P8254-E**  
Appliance pull  
Length:  
612mm, 24<sup>1</sup>/<sub>8</sub>"  
Centres:  
450mm, 17<sup>11</sup>/<sub>16</sub>"



**P8254-B**  
Length:  
225mm, 8<sup>7</sup>/<sub>8</sub>"  
Centres:  
150mm, 5<sup>7</sup>/<sub>8</sub>"



**P8254-F**  
Appliance pull  
Length:  
762mm, 30"  
Centres:  
600mm, 23<sup>5</sup>/<sub>8</sub>"



**P8254-C**  
Length:  
275mm, 10<sup>13</sup>/<sub>16</sub>"  
Centres:  
200mm, 7<sup>7</sup>/<sub>8</sub>"



**P8254-D**  
Length:  
462mm, 18<sup>3</sup>/<sub>16</sub>"  
Centres:  
300mm, 11<sup>13</sup>/<sub>16</sub>"



The reeded end sections can be ordered as split finishes. Visit our website to view each product in each finish available.



V7K32LF Landmark/V7KA32LF LMK Pure single lever kitchen mixer in brushed nickel.

**SAMUEL HEATH**

*Handmade in England*

REEDED  
cabinet hardware collection

P799L-B

Reeded cabinet hardware in Old brass matt  
and Anthracite.

P799L-B

SAMUEL HEATH

*Handmade in England*

# Reeded

## P799L and P800L Cabinet knobs



**P799L-A**  
 Diameter: Ø 25mm, 1"  
 Projection: 25mm, 1"



**P800L-A**  
 Diameter: Ø 20mm, 13/16"  
 Projection: 25mm, 1"



**P799L-B**  
 Diameter: Ø 32mm, 1 1/4"  
 Projection: 32mm, 1 1/4"



**P800L-B**  
 Diameter: Ø 20mm, 13/16"  
 Projection: 32mm, 1 1/4"



CP Chrome plate	PN Polished nickel	BN Brushed nickel	NL Non lacquered brass	PB Polished brass	MBC Matt black chrome	ABU Antique brass unlacquered	BG Brushed gold	BGG Brushed gold gloss	BGM Brushed gold matt	ANT Anthracite	ABM Antique brass matt	ABG Antique brass gloss	AMR Amber brass	OBM Old brass matt	CTB City bronze	CNB Country bronze
-----------------------	--------------------------	-------------------------	---------------------------------	-------------------------	--------------------------------	--	-----------------------	---------------------------------	--------------------------------	-------------------	---------------------------------	----------------------------------	-----------------------	-----------------------------	-----------------------	--------------------------

Visit our website to view each product in each finish available.

BAUHAUS  
cabinet hardware collection

P8257-E

P8257-E

P8257-E

P8257-E Bauhaus appliance pull handles in City bronze.

# Bauhaus

## P8257 Cabinet and appliance pull handles

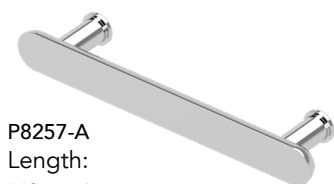

**P8257-A**  
Length:  
168mm, 6<sup>5</sup>/<sub>8</sub>"  
Centres:  
128mm, 5<sup>1</sup>/<sub>16</sub>"

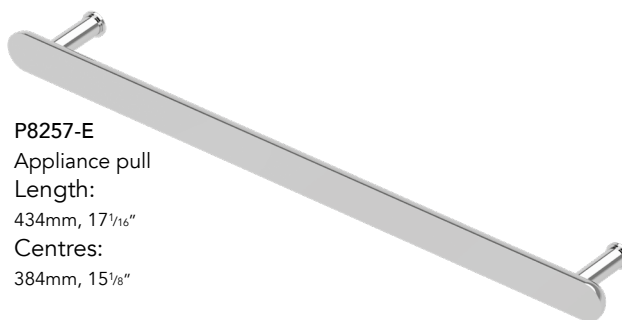

**P8257-E**  
Appliance pull  
Length:  
434mm, 17<sup>1</sup>/<sub>16</sub>"  
Centres:  
384mm, 15<sup>1</sup>/<sub>8</sub>"

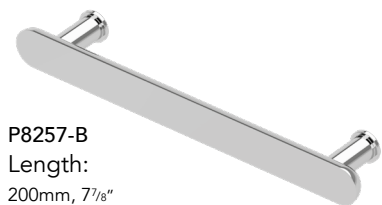

**P8257-B**  
Length:  
200mm, 7<sup>7</sup>/<sub>8</sub>"  
Centres:  
160mm, 6<sup>5</sup>/<sub>16</sub>"

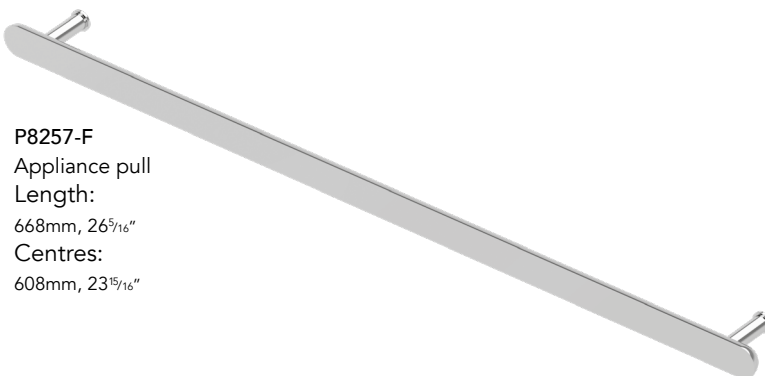

**P8257-F**  
Appliance pull  
Length:  
668mm, 26<sup>5</sup>/<sub>16</sub>"  
Centres:  
608mm, 23<sup>15</sup>/<sub>16</sub>"

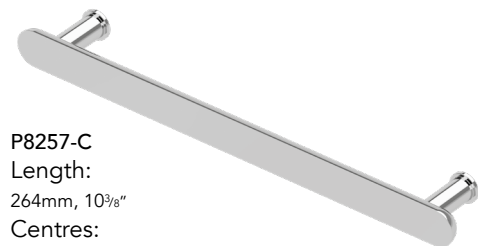

**P8257-C**  
Length:  
264mm, 10<sup>3</sup>/<sub>8</sub>"  
Centres:  
224mm, 8<sup>13</sup>/<sub>16</sub>"

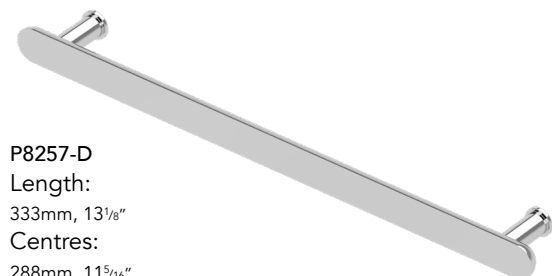

**P8257-D**  
Length:  
333mm, 13<sup>1</sup>/<sub>8</sub>"  
Centres:  
288mm, 11<sup>5</sup>/<sub>16</sub>"

*Polishing flat surfaces takes real skill and attention to detail, and we ensure the highest possible quality by machining only from solid brass billets. Casting these handles would be easier, but the quality would not match.*

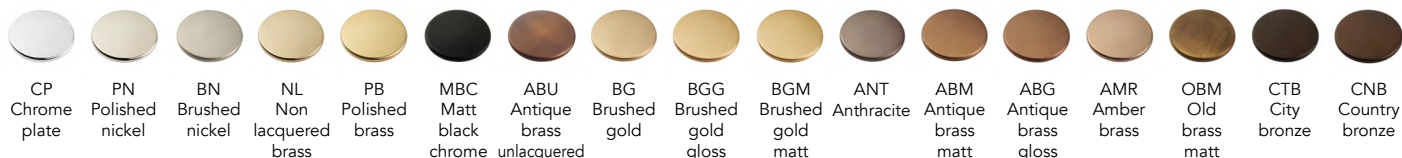

Visit our website to view each product in each finish available.

# Bauhaus

## PK8257P Cabinet and appliance pull handles

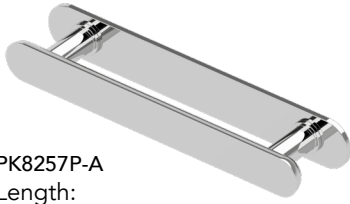

**PK8257P-A**  
Length:  
173mm, 6<sup>13</sup>/<sub>16</sub>"  
Centres:  
128mm, 5<sup>1</sup>/<sub>16</sub>"

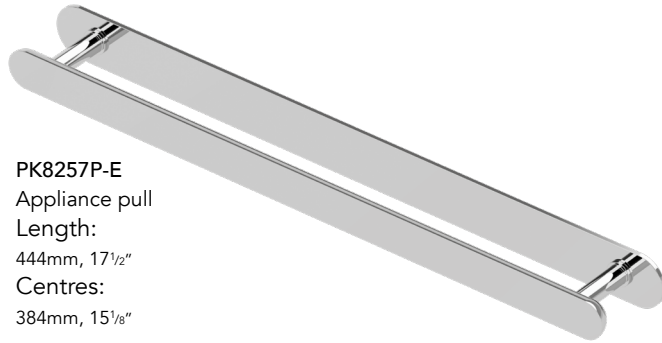

**PK8257P-E**  
Appliance pull  
Length:  
444mm, 17<sup>1</sup>/<sub>2</sub>"  
Centres:  
384mm, 15<sup>1</sup>/<sub>8</sub>"

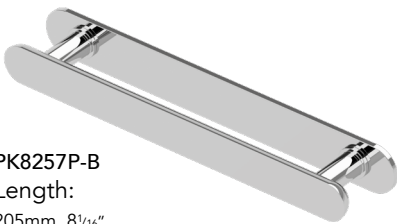

**PK8257P-B**  
Length:  
205mm, 8<sup>1</sup>/<sub>16</sub>"  
Centres:  
160mm, 6<sup>5</sup>/<sub>16</sub>"

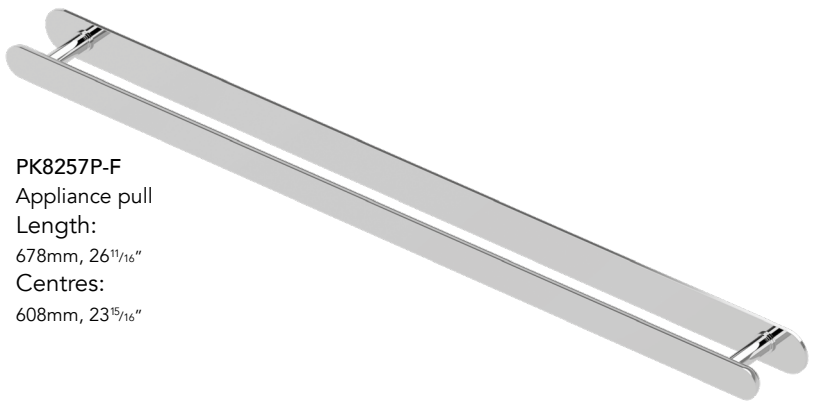

**PK8257P-F**  
Appliance pull  
Length:  
678mm, 26<sup>11</sup>/<sub>16</sub>"  
Centres:  
608mm, 23<sup>15</sup>/<sub>16</sub>"

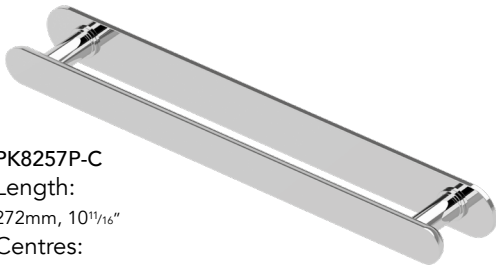

**PK8257P-C**  
Length:  
272mm, 10<sup>11</sup>/<sub>16</sub>"  
Centres:  
224mm, 8<sup>13</sup>/<sub>16</sub>"

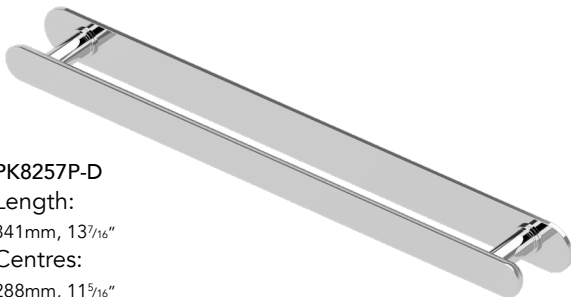

**PK8257P-D**  
Length:  
341mm, 13<sup>7</sup>/<sub>16</sub>"  
Centres:  
288mm, 11<sup>5</sup>/<sub>16</sub>"



Visit our website to view each product in each finish available.

BAUHAUS  
cabinet hardware collection

P801-B

P8257-B

P801-B

P800F-B

P799F-B

P799F-B

P8257-B

P8257-B Bauhaus cabinet pull handles  
in polished nickel.

Also: P801-B cabinet knobs,  
P799F-B cabinet knobs and  
P800F-B cabinet knobs all in polished nickel.

SAMUEL HEATH

*Handmade in England*



V7K33LF Landmark/ V7KA33LF LMK Pure single lever kitchen mixer in City bronze.

SAMUEL HEATH

*Handmade in England*

# Bauhaus

## P8252 Cabinet and appliance pull handles



**P8252-A**  
Length:  
175mm, 6<sup>7</sup>/<sub>8</sub>"  
Centres:  
100mm, 3<sup>15</sup>/<sub>16</sub>"



**P8252-E**  
Appliance pull  
Length:  
612mm, 24<sup>1</sup>/<sub>8</sub>"  
Centres:  
450mm, 17<sup>11</sup>/<sub>16</sub>"



**P8252-B**  
Length:  
225mm, 8<sup>7</sup>/<sub>8</sub>"  
Centres:  
150mm, 5<sup>7</sup>/<sub>8</sub>"



**P8252-F**  
Appliance pull  
Length:  
761.5mm, 30"  
Centres:  
599.5mm, 23<sup>5</sup>/<sub>8</sub>"



**P8252-C**  
Length:  
275mm, 10<sup>13</sup>/<sub>16</sub>"  
Centres:  
200mm, 7<sup>7</sup>/<sub>8</sub>"



**P8252-D**  
Length:  
461.5mm, 18<sup>3</sup>/<sub>16</sub>"  
Centres:  
300mm, 11<sup>13</sup>/<sub>16</sub>"



The machined end sections can be ordered as split finishes. Visit our website to view each product in each finish available.

# Bauhaus

## P799F, P800F and P801 Cabinet knobs



**P799F-A**  
 Diameter: Ø 25mm, 1"  
 Projection: 25mm, 1"



**P799F-B**  
 Diameter: Ø 32mm, 1¼"  
 Projection: 32mm, 1¼"



**P800F-A**  
 Diameter: Ø 20mm, 13/16"  
 Projection: 25mm, 1"



**P801-A**  
 Diameter: Ø 25mm, 1"  
 Projection: 25mm, 1"



**P800F-B**  
 Diameter: Ø 20mm, 13/16"  
 Projection: 32mm, 1¼"



**P801-B**  
 Diameter: Ø 32mm, 1¼"  
 Projection: 30mm, 13/16"



Visit our website to view each product in each finish available.

# Cabinet knobs



**P783**  
 Diameter: 20mm, <sup>13</sup>/<sub>16</sub>" x 32mm, 1<sup>1</sup>/<sub>4</sub>"  
 Projection: 26mm, 1"



**P784**  
 Diameter: 24mm, <sup>15</sup>/<sub>16</sub>" x 32mm, 1<sup>1</sup>/<sub>4</sub>"  
 Projection: 26mm, 1"



**P788-B**  
 Diameter: Ø 25mm, 1"  
 Projection: 23.5mm, <sup>15</sup>/<sub>16</sub>"



**P786-A**  
 Diameter: Ø 20mm, <sup>13</sup>/<sub>16</sub>"  
 Projection: 32mm, 1<sup>1</sup>/<sub>4</sub>"



**P787-A**  
 Diameter: Ø 20mm, <sup>13</sup>/<sub>16</sub>"  
 Projection: 32mm, 1<sup>1</sup>/<sub>4</sub>"



**P788-C**  
 Diameter: Ø 32mm, 1<sup>1</sup>/<sub>4</sub>"  
 Projection: 31mm, 1<sup>1</sup>/<sub>4</sub>"



**P786-B**  
 Diameter: Ø 26mm, 1"  
 Projection: 39mm, 1<sup>9</sup>/<sub>16</sub>"



**P787-B**  
 Diameter: Ø 26mm, 1"  
 Projection: 39mm, 1<sup>9</sup>/<sub>16</sub>"



**P789-B**  
 Diameter: Ø 25mm, 1"  
 Projection: 23.5mm, <sup>15</sup>/<sub>16</sub>"



**P786-C**  
 Diameter: Ø 31mm, 1<sup>1</sup>/<sub>4</sub>"  
 Projection: 46mm, 1<sup>13</sup>/<sub>16</sub>"



**P787-C**  
 Diameter: Ø 31mm, 1<sup>1</sup>/<sub>4</sub>"  
 Projection: 46mm, 1<sup>13</sup>/<sub>16</sub>"



**P789-C**  
 Diameter: Ø 32mm, 1<sup>1</sup>/<sub>4</sub>"  
 Projection: 31mm, 1<sup>3</sup>/<sub>16</sub>"



Visit our website to view each product in each finish available.

# Cabinet knobs



**P796-A**  
 Diameter: knob Ø 19mm, 3/4"  
 base Ø 22mm, 7/8"  
 Projection: 34mm, 1 5/16"



**P797-A**  
 Diameter: knob Ø 19mm, 3/4"  
 base Ø 22mm, 7/8"  
 Projection: 34mm, 1 3/8"



**P796-B**  
 Diameter: knob Ø 25mm, 1"  
 base Ø 29mm, 1 1/8"  
 Projection: 42mm, 1 11/16"



**P797-B**  
 Diameter: knob Ø 25mm, 1"  
 base Ø 29mm, 1 1/8"  
 Projection: 41.5mm, 1 5/8"



**P798-B**  
 Diameter: knob Ø 24mm, 15/16"  
 base Ø 29.5mm, 1 3/16"  
 Projection: 29.5mm, 1 3/16"



**P799-B**  
 Diameter: knob Ø 24mm, 15/16"  
 base Ø 29.5mm, 1 3/16"  
 Projection: 29.5mm, 1 3/16"



**P796-C**  
 Diameter: knob Ø 32mm, 1 1/4"  
 base Ø 35mm, 1 3/8"  
 Projection: 54mm, 2 1/8"



**P797-C**  
 Diameter: knob Ø 32mm, 1 1/4"  
 base Ø 35mm, 1 3/8"  
 Projection: 54mm, 2 1/8"



**P798-C**  
 Diameter: knob Ø 32mm, 1 1/4"  
 base Ø 38mm, 1 1/2"  
 Projection: 37.5mm, 1 1/2"



**P799-C**  
 Diameter: knob Ø 32mm, 1 1/4"  
 base Ø 38mm, 1 1/2"  
 Projection: 37.5mm, 1 1/2"



Visit our website to view each product in each finish available.

LANDMARK / LMK, REEDED & BAUHAUS  
door lever hardware collections



Please visit [samuel-heath.com](https://www.samuel-heath.com) for full details of these and all of our brassware collections.

*Experience the full selection of Samuel Heath finishes with our beautiful finish swatch collection. Finish discs can be ordered separately as well. Please let us know if you would like a set.*



**SAMUEL HEATH**

*Handmade in England*

*Visitors to our factory in Birmingham,  
England are always welcome. We also  
have a showroom in Design Centre,  
Chelsea Harbour, London.  
Please get in touch if you'd like to visit us.*

Samuel Heath Head office and factory  
Leopold Street  
Birmingham  
England B12 0UJ

T: Customer Service +44 (0)121 766 4200  
E: [info@samuel-heath.com](mailto:info@samuel-heath.com)

**[samuel-heath.com](http://samuel-heath.com)**



London Showroom  
Design Centre Chelsea Harbour  
1st Floor, North Dome  
London SW10 0XE

T: +44 (0)20 7352 0249

US Customer Service  
139 East 35th Street,  
Suite 2-J  
New York, NY 10016

T: (212) 696 0050  
E: [usa@samuel-heath.com](mailto:usa@samuel-heath.com)